

eco**technique** écot**technique** öko**technik**

tecnico

eco**tecnico**

476 **technic**

486 **tactile**

TECNICO

Materiale, prodotto, componente dotato di proprietà e caratteristiche prestazionali individuate o definite in rapporto alla sua origine e all'impiego a cui è destinato, che ne determinano il livello e il conseguente grado di specializzazione. Le proprietà e le caratteristiche sono valutabili secondo unità di misura, grandezze, capacità e procedure di prova rilevabili attraverso specifiche unanimemente condivise.

TECHNICAL

Material, product or component possessing properties and performance specifications identified or defined depending on their origin and the use for which they have been designed, and that determine their level and consequent degree of specialisation. The properties and characteristics can be evaluated according to units of measurement, magnitudes, capacities and test procedures established by universally accepted specifications.





technic

GRANITOGRES

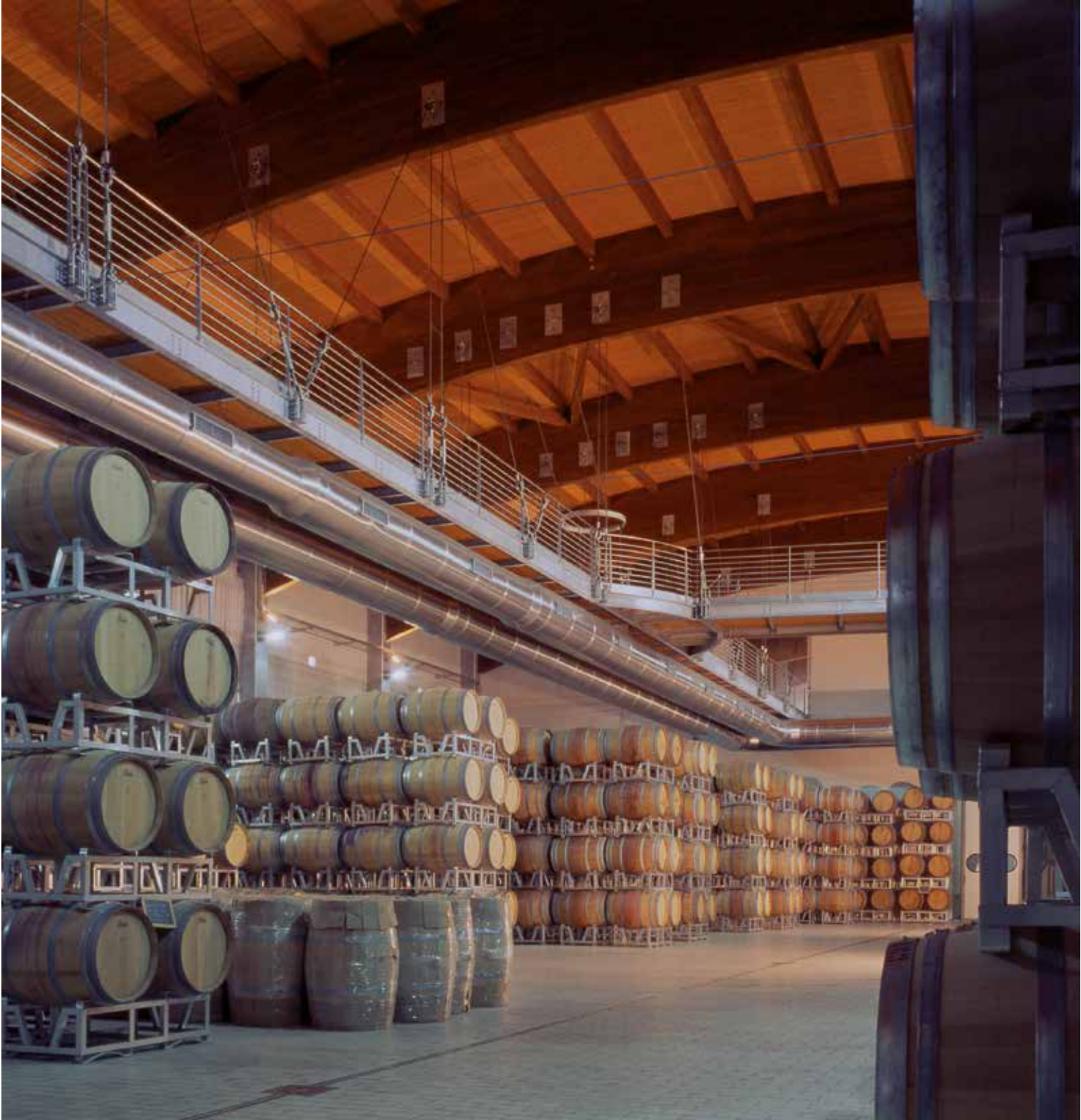

nebraska cm 20x20 - 77/8"x77/8"

COLORI COLOURS COULEURS FARBEN

grigio cenere



bianco avorio



bianco B



colorado



sahara



nebraska

technic

GRANITOGRES

ontario



arkansas

Landscape tundra 100 satin lucida



Landscape beach 101 satin

Rivestimenti smaltati
Glazed tiles
Revêtement émaillé
Fliesen aus glasiertem Feinsteinzeug

COLORI COLOURS COULEURS FARBEN

technic R10



roccia R12 (A+B+C)



profil R12 - V8 (A+B+C)



reticolo R12 - V4 (A+B+C)



carbo R12



sicura R11 (A+B)

technic

GRANITOGRES

bugnato R11 - V6 (A+B+C)

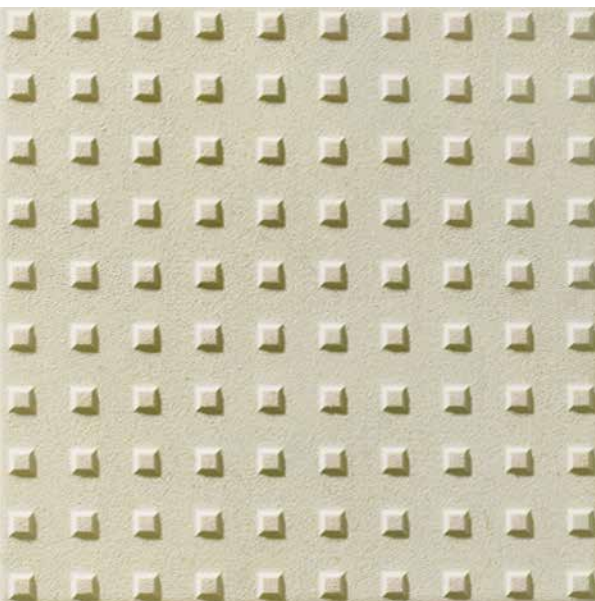



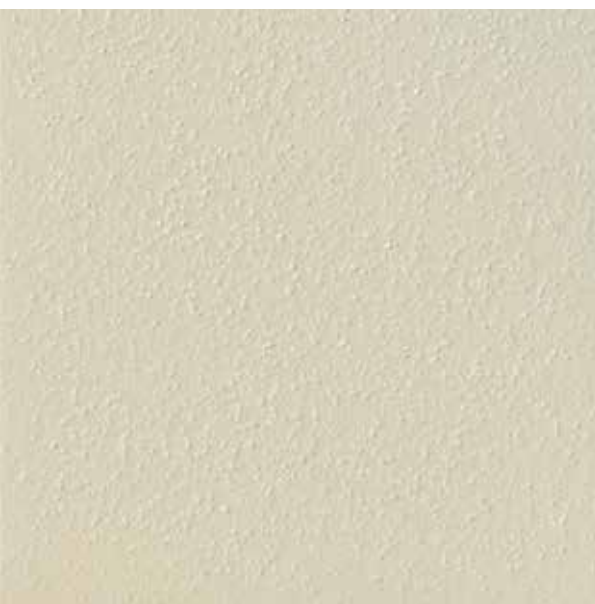





pavè R11 - V4 (A+B+C)



safe R13 (A+B+C)
agrèé par la CNAMTS

FORMATI SIZES FORMATS FORMATE

GRES PORCELLANATO NON SMALTATO UNGLAZED PORCELAIN STONEWARE GRÉS CÉRAME NON ÉMAILLÉ UNGLASIERTE FEINSTEINZEUGFLIESEN

Formati Sizes Formats Formate	 cm 15x15 5 ⁷ / ₈ "x5 ⁷ / ₈ "	 mm	 cm 20x20 7 ⁷ / ₈ "x7 ⁷ / ₈ "	 mm	 cm 12,5x25[▲] 4 ⁷ / ₈ "x 9 ⁷ / ₈ "	 mm	 cm 30x30 11 ³ / ₄ "x11 ³ / ₄ "	 mm
Roccia	■		■	8/12/14,2	■	8	■	8/11,2/14,2
Bugnato			■	8/12/14,2				
Profil	■	8	■	8/12/14,2				
Pavè			■	8/12/14,2	■	8		
Secura	■	8	■	8/12/14,2	■	8	■	8/11,2/14,2
Carbo			■	8,5/12*				
Technic	■	8	■	8/12/14,2	■	8	■	8/11,2/14,2
Reticolo	■	8	■	8/12/14,2**				
Safe			■	8/12***				

GRES PORCELLANATO SMALTATO GLAZED PORCELAIN STONEWARE GRÉS CÉRAME ÉMAILLÉ GLASIERTE FEINSTEINZEUGFLIESEN

Formati Sizes Formats Formate	 cm 12,5x25[▲] 4 ⁷ / ₈ "x 9 ⁷ / ₈ "
Satin	■ 8
Lucida	■ 8

▲ Dimensioni di fabbricazione 118x243. La modularità si ottiene con una fuga di 7mm
Factory size 118x243. For modular laying, install with a 7 mm joint
Dimensions de fabrication 118x243. Calpinage avec un joint de 7 mm
Fertigungsgröße 118x243. Die Modularität wird mit einer 7 mm Füge erzielt

* Produzione nei colori: Currently produced in the following colours:
Production dans les couleurs: Lieferbar in den Farben: **Bianco Avorio**

** Produzione nei colori: Currently produced in the following colours:
Production dans les couleurs: Lieferbar in den Farben: **Nebraska, Arkansas**

*** Produzione nei colori: Currently produced in the following colours:
Production dans les couleurs: Lieferbar in den Farben: **Bianco Avorio, Bianco B**

Caratteristiche tecniche e imballi a pagina: Technical features and packing on page: Caractéristiques techniques et emballages à la page: Technische Eigenschaften und Verpackungen auf Seite: **494**

PEZZI SPECIALI TRIMS ACCESSOIRES FORMSTÜCKE

Battiscopa Bullnose Plinthe à bord arrondi Stehsockel

cm 9x30 - 3¹/₂"x11³/₄"
cm 10x20 - 4"x7⁷/₈"

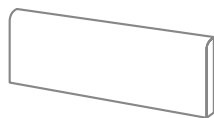

Gradino Step tread Nez de marche Stufenplatte

cm 30x30 - 11³/₄"x11³/₄"

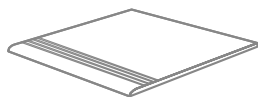

Sguscezza Cove Gorge Rinnleiste

cm 4x20 - 1¹/₂"x7⁷/₈"



Angolare Longitudinal angle Angulaire Schenkelplatte

cm 20x5x5 - 7⁷/₈"x2"x2"

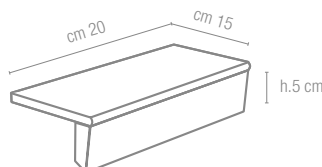

Zoccolo a raccordo a taglio retto

Cove base - straight top

Plinthe à gorge avec bord vif

Hohlkehlsocle (scharfkantig)

cm 10x20 - 4"x7⁷/₈"

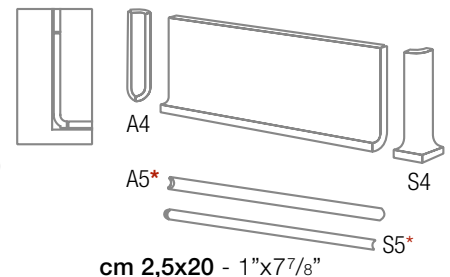

cm 2,5x20 - 1"x7⁷/₈"

Zoccolo ad appoggio smussato

Sit-on skirting - bevelled top

Plinthe à talon avec bord arrondi

Aufsetzsockel mit
abgerundeter Kante

cm 10x20 - 4"x7⁷/₈"

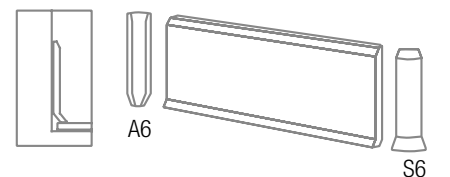

SUPERFICI SURFACES SURFACES OBERFLÄCHEN

technic

GRANITOGRES



14,2 mm

11,2/12 mm

8 mm

PEZZI SPECIALI **MODULO M 12,5x25** MODULAR TRIMS ACCESSOIRES MODULAIRES MODULAR FORMSTÜCKE

SISTEMA CANALETTA 1 CHANNEL SYSTEM 1 SYSTEME CANIVEAU 1 RINNESYSTEM 1

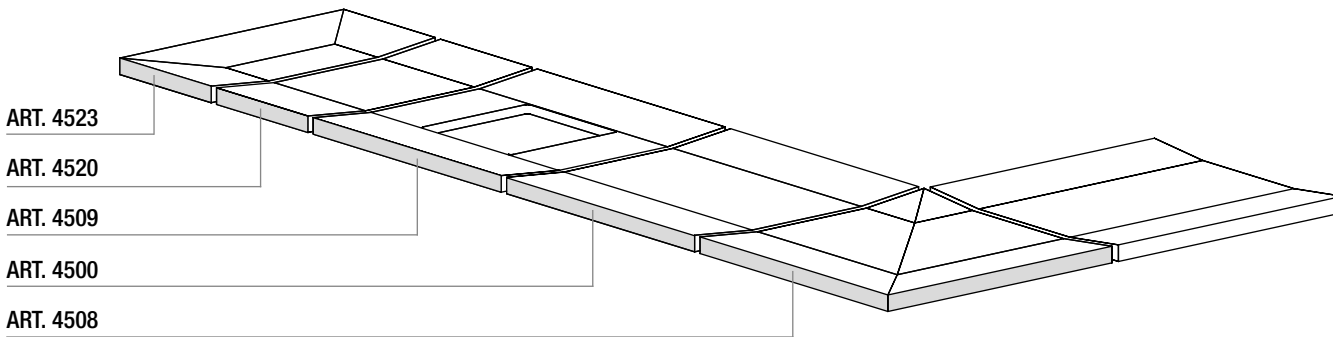

ART. 4523

ART. 4520

ART. 4509

ART. 4500

ART. 4508

ART. 4523

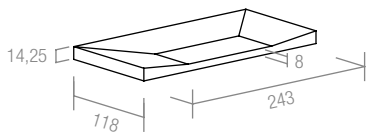

ART. 4520

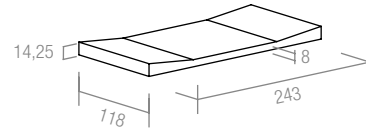

ART. 4509

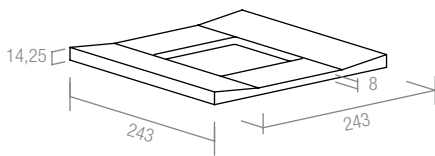

ART. 4500

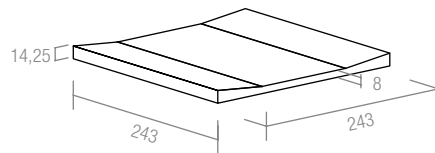

ART. 4508

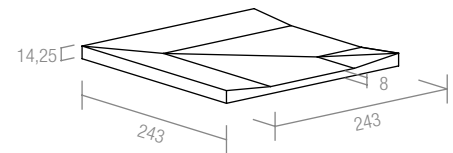

Produzione nei colori:
Currently produced
in the following
colours:
Production dans
les couleurs :
Lieferbar in den
Farben:
Bianco Avorio,
Bianco B
Superficie: Surface:
Surface : Oberfläche:
grip

SISTEMA CANALETTA 2 CHANNEL SYSTEM 2 SYSTEME CANIVEAU 2 RINNESYSTEM 2

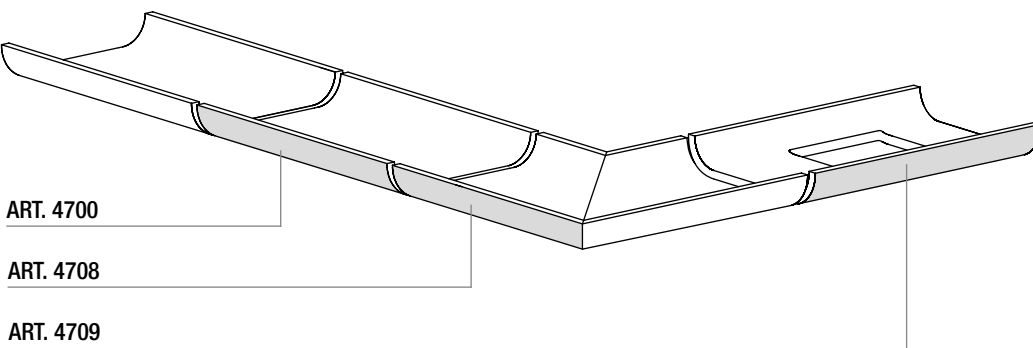

ART. 4700

ART. 4708

ART. 4709

ART. 4700

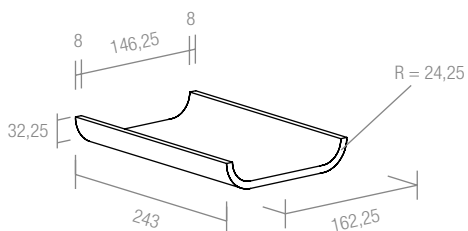

ART. 4708

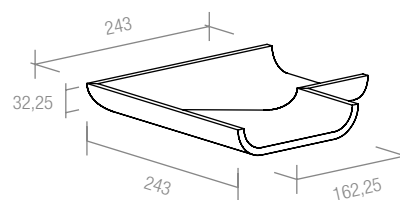

ART. 4709

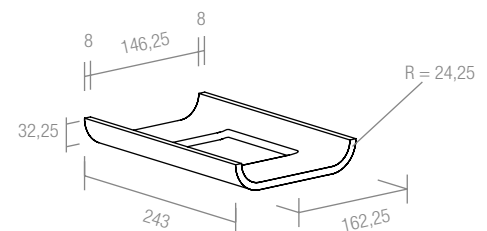

Produzione nei colori:
Currently produced
in the following
colours:
Production dans
les couleurs :
Lieferbar in den
Farben:
Tundra 100
Superficie: Surface:
Surface : Oberfläche:
satın

technic

GRANITOGRES

SISTEMA BECCO DI CIVETTA BULLNOSE SYSTEM SYSTEME BORD ARRONDI STEH SOCKELSYSTEM

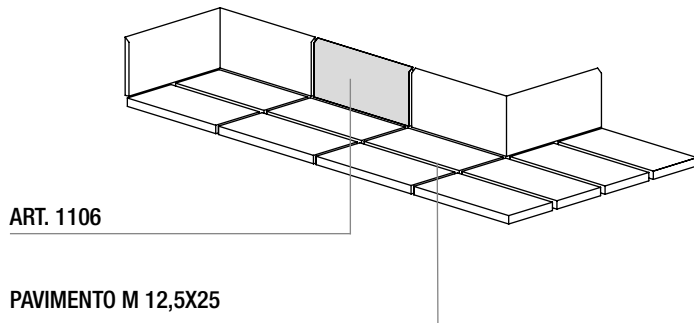

ART. 1106

PAVIMENTO M 12,5X25

Produzione nei colori:
Currently produced in the following colours:
Production dans les couleurs :
Lieferbar in den Farben:
Bianco Avorio, Bianco B
Superficie: Surface: Surface : Oberfläche: **matt**
Tundra 100, Beach 101
Superficie: Surface: Surface : Oberfläche: **satin**

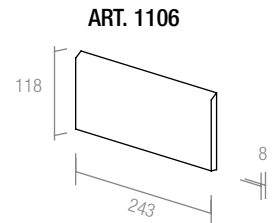

SISTEMA ZOCCOLO A RACCORDO SMUSSATO COVE BASE SYSTEM WITH BEVELLED TOP SYSTEME PLINTHE A GORGE BISEAUTE HOHKEHL SOCKELSYSTEM MIT ABGERUNDETER KANTE

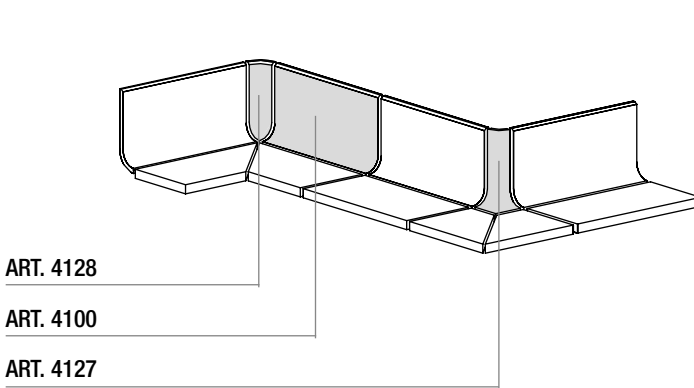

ART. 4128

ART. 4100

ART. 4127

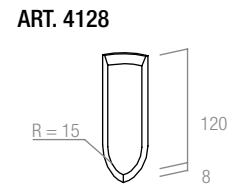
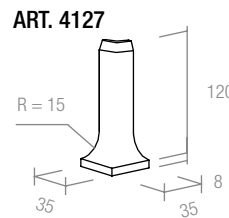

Produzione nei colori:
Currently produced in the following colours:
Production dans les couleurs :
Lieferbar in den Farben:
Bianco Avorio, Bianco B
Superficie: Surface: Surface : Oberfläche: **matt**
Tundra 100, Beach 101
Superficie: Surface: Surface : Oberfläche: **satin**

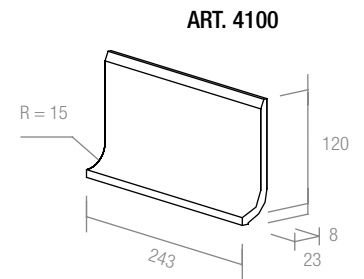

SISTEMA SGUSCETTA COVE SYSTEM SYSTEME GORGE RINNENLEISTESYSTEM

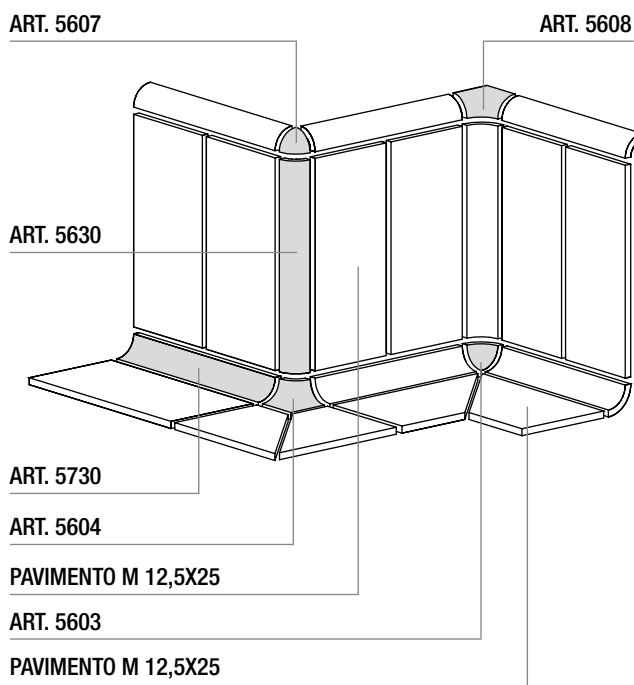

ART. 5607

ART. 5608

ART. 5630

ART. 5730

ART. 5604

PAVIMENTO M 12,5X25

ART. 5603

PAVIMENTO M 12,5X25

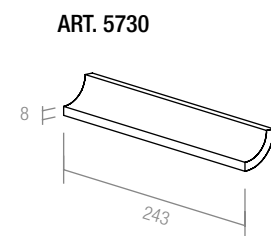
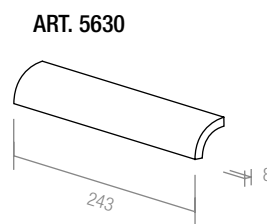

Produzione nei colori:
Currently produced in the following colours:
Production dans les couleurs :
Lieferbar in den Farben:
Bianco Avorio, Bianco B
Superficie: Surface: Surface : Oberfläche: **matt**
Tundra 100
Superficie: Surface: Surface : Oberfläche: **satin, lucida**
Beach 101
Superficie: Surface: Surface : Oberfläche: **satin**

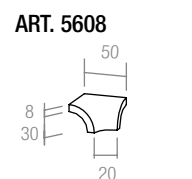
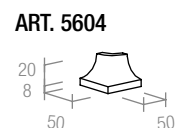
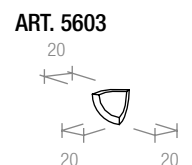

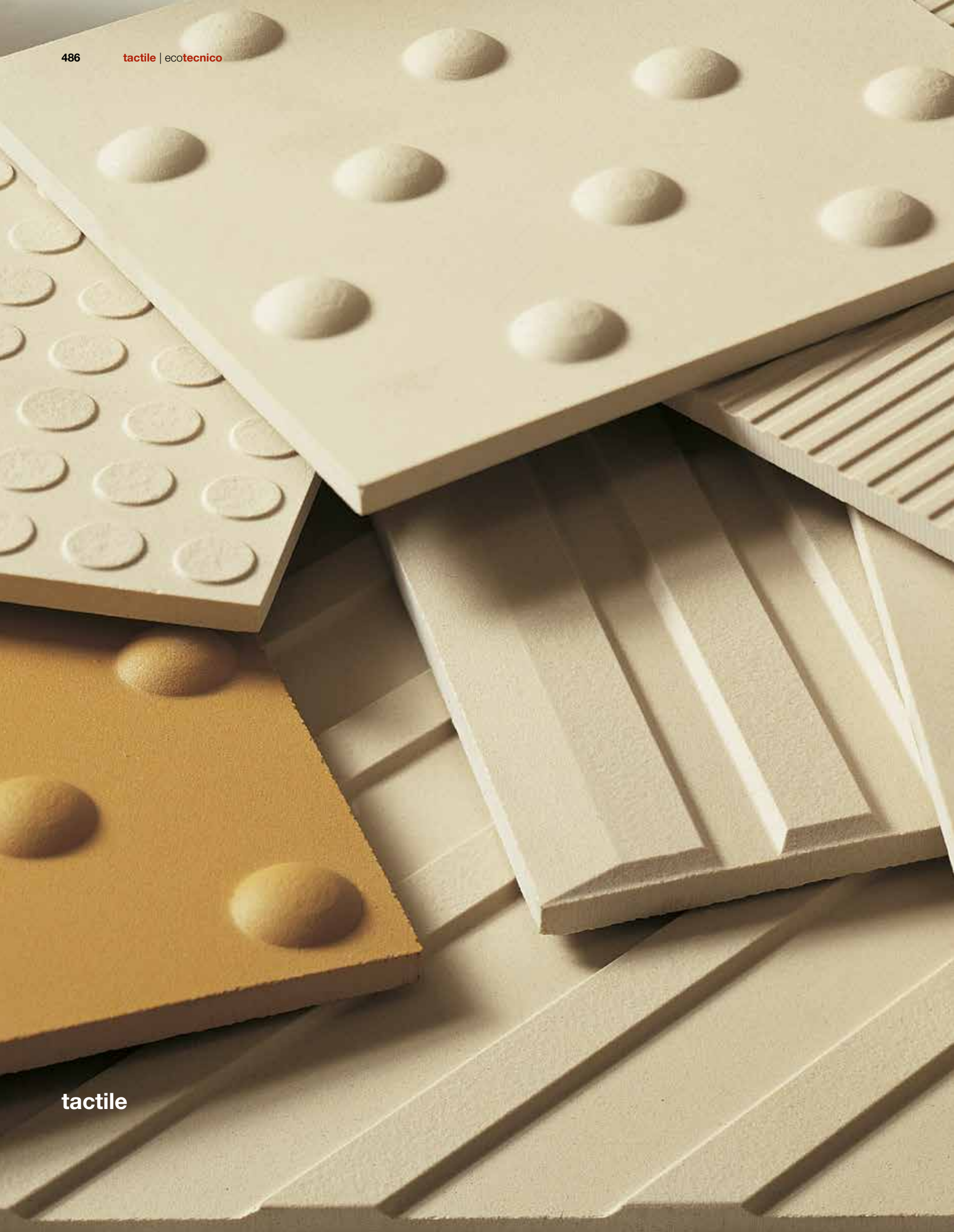

tactile

GRANITOGRES



tactile, ontario segura cm 30x30 - 11³/₄"x 11³/₄"

COLORI COLOURS COULEURS FARBEN

budapest



shanghai

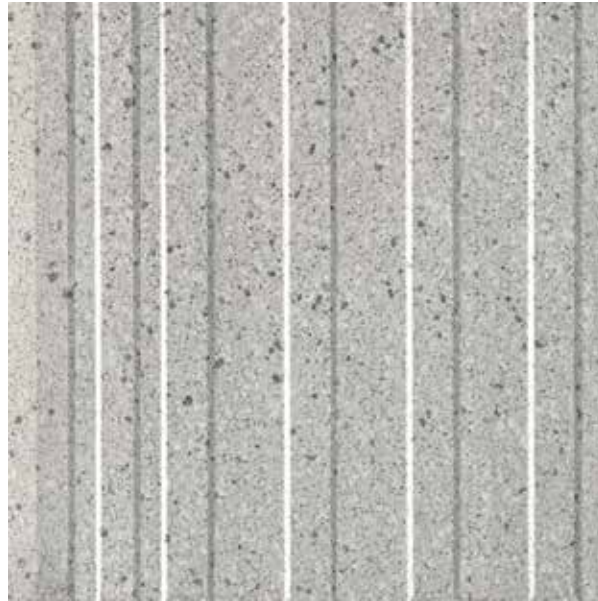

bianco avorio

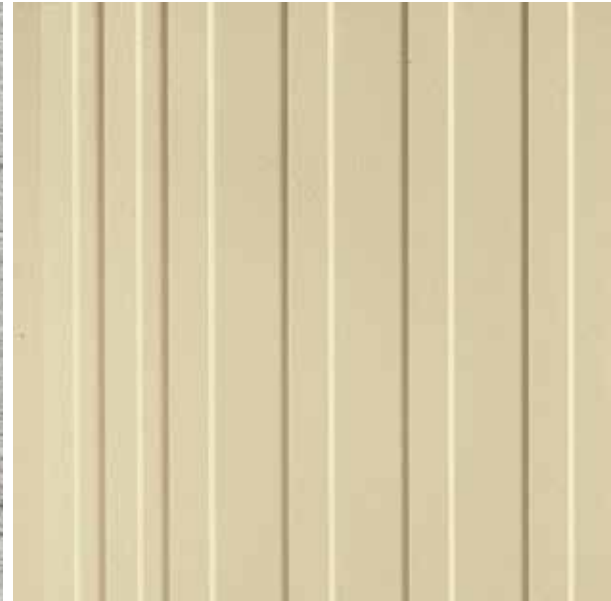

madrid

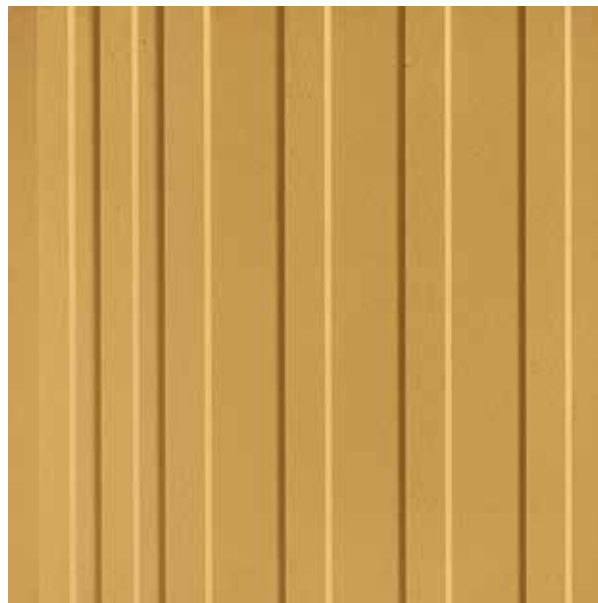

giallo ocra

Eventuali altri colori possono essere richiesti dal progettista per particolari esigenze architettoniche o progettuali.

Other colours may be requested by the designer for specific architectural or design needs.

D'autres couleurs peuvent être éventuellement demandées par le projeteur pour exigences architecturales ou projectuelles.

Evt. andere Farben können von Architekt, im Fall Von besondere Baubedürfnisse, nachgefragt werden.

PERCORSO GUIDA PER DISABILI VISIVI
 GUIDED PATH FOR VISUALLY DISABLED PEOPLE
 PARCOURS GUIDE POUR LES MALVOYANT ET AVEUGLES
 SEHEBEHINDERTLEITWEG

tactile
 GRANITOGRES

Codice di direzione rettilinea
 Straight direction code
 Code de direction rectiligne
 Geradlinige Richtung

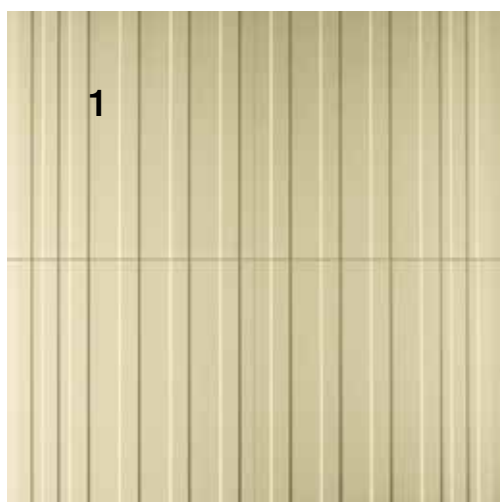

Codice di incrocio a T
 T-junction code
 Code de croisement en T
 T-förmige Kreuzung



Codice di svolta obbligata ad L
 Compulsory L-turn code
 Code de tournant obligatoire en L
 Obligatorisches L-förmiges Abbiegen

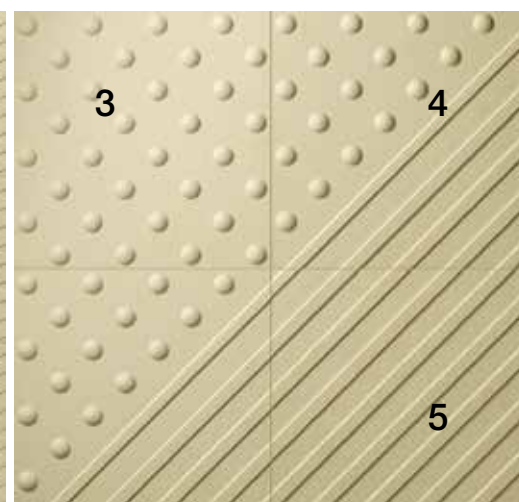

Codice di arresto-pericolo
 Stop-danger code
 Code d'arrêt-danger
 Stehenbleiben-Gefahr



Codice di pericolo valicabile
 Dangerous to pass code
 Code de danger franchissable
 Überwindbare Gefahr

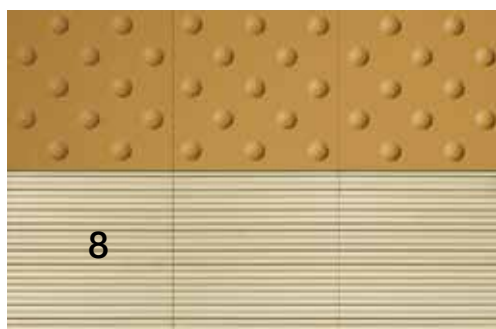

Codice di attenzione-servizio
 Attention-service code
 Code d'attention-service
 Achtung-Service



- 1. art. 30x30 rettilineo
- 2. art. 20x20 borchie
- 3. art. 30x30 tondi
- 4. art. 30x30 diagonale/tondi

- 5. art. 30x30 diagonale
- 6. art. 20x20 12 tondi
- 7. art. 20x20 13 tondi
- 8. art. 20x20 righe